

Article number: 2310415131

Description: E+G Vibration-damping levelling element
LW.A-160-M20x1.5x170

Measures

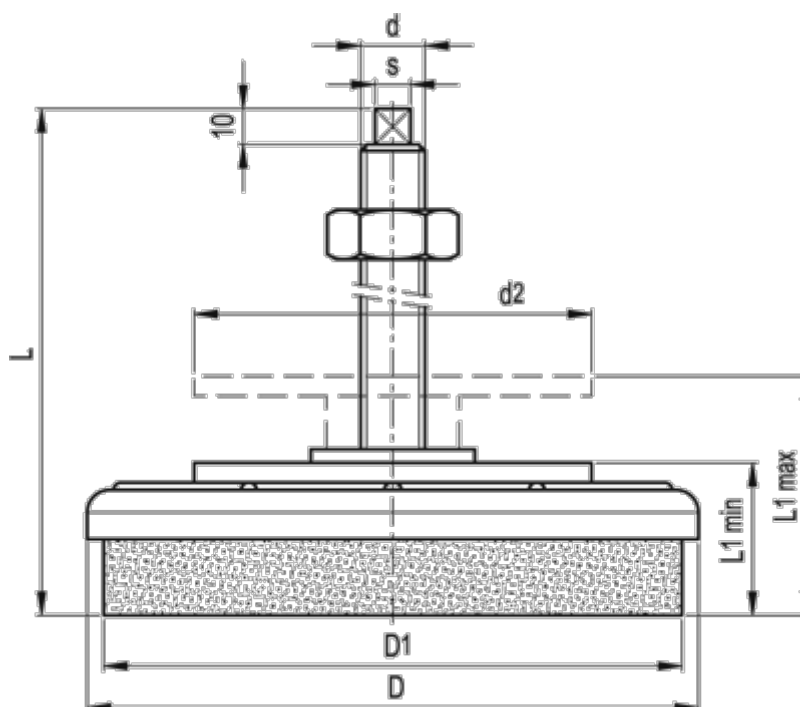

d	= M20x1.5	s	= 12x12
D	= 160	Static load (N)	= 20000
d1	= 150	Stiffness (N/mm)	= 9000
d2	= 130	Weight (g)	= 2650
L	= 192		
L1 max.	= 70		
L1 min.	= 55		
Max deflection	= 2.2		